

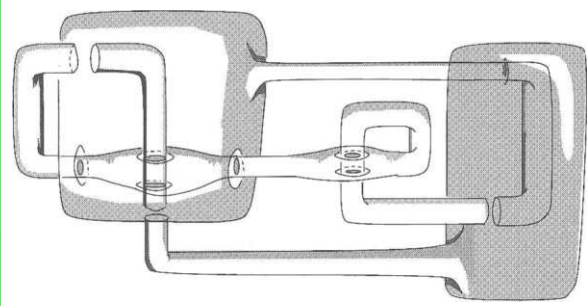

Abstract. Much as we can understand 3-dimensional objects by staring at their pictures and x-ray images and slices in 2-dimensions, so can we understand 4-dimensional objects by staring at their pictures and x-ray images and slices in 3-dimensions, capitalizing on the fact that we understand 3-dimensions pretty well. So we will spend some time staring at and understanding various 2-dimensional views of a 3-dimensional elephant, and then even more simply, various 2-dimensional views of some 3-dimensional knots. This achieved, we'll take the leap and visualize some 4-dimensional knots by their various traces in 3-dimensional space, and if we'll still have time, we'll prove that these knots are really knotted.



ω/CS

Yet another 4D Knot.

Flatlanders View an Elephant.

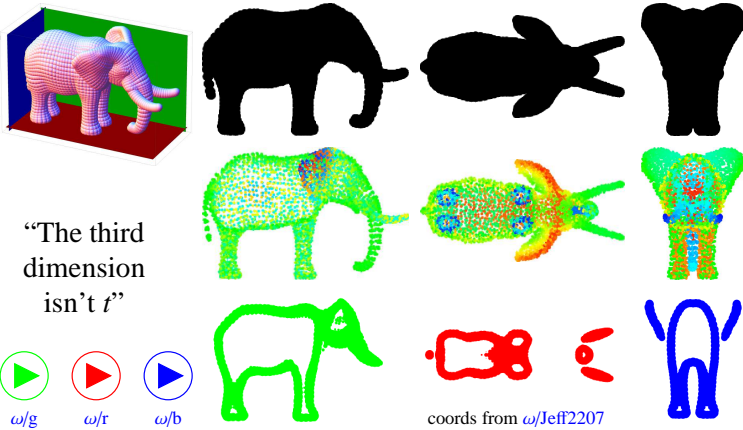

Some Movies

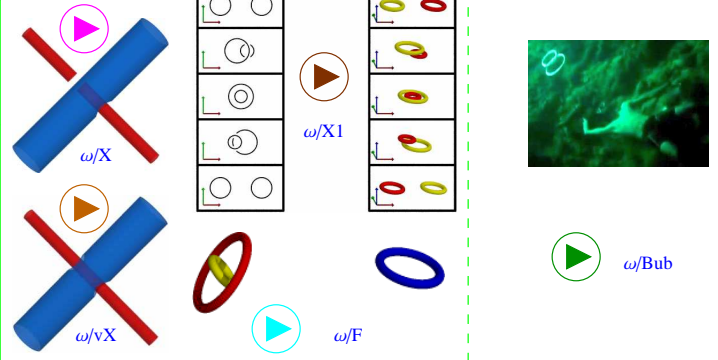

Some Unknots



Knots.

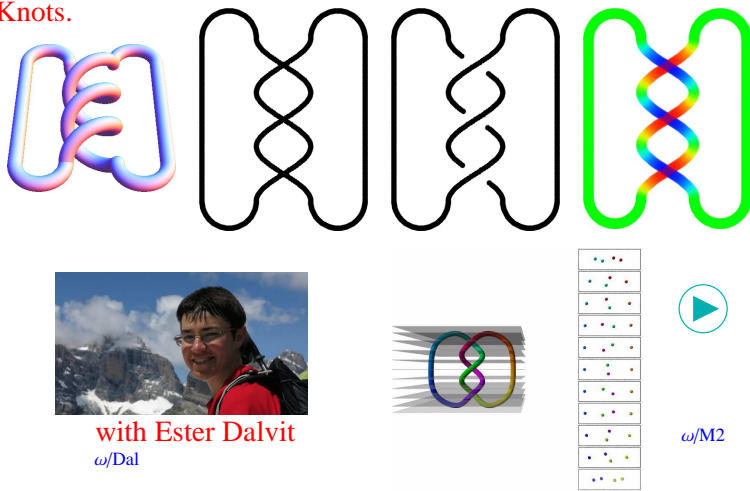

Reidemeister' Theorem. Two knot diagrams represent the same 3D knot iff they differ by a sequence of "Reidemeister moves":

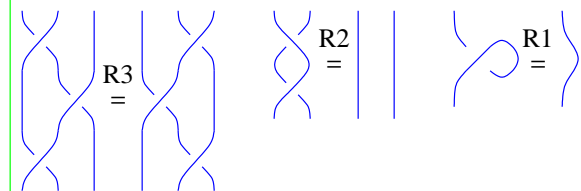

3-Colourings. Colour the arcs of a broken arc diagram in RGB so that every crossing is either mono-chromatic or tri-chromatic. Let $\lambda(K)$ be the number of such 3-colourings that K has.

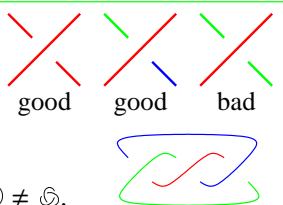

Example. $\lambda(\bigcirc) = 3$ while $\lambda(\bigoplus) = 9$; so $\bigcirc \neq \bigoplus$.

4D Knots.

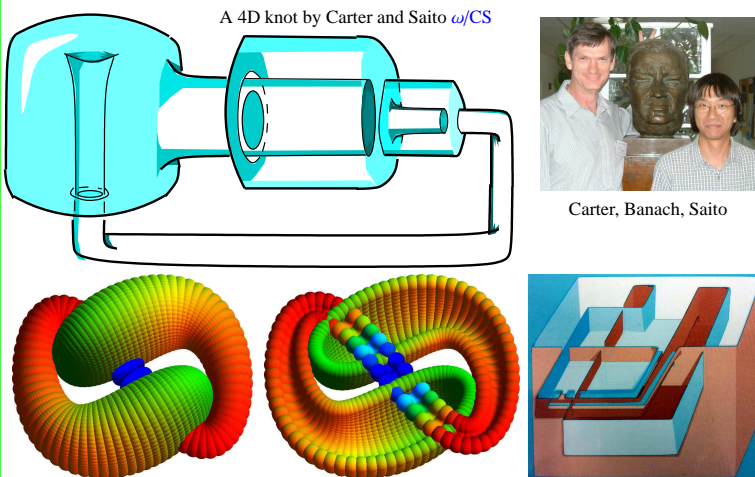

A Knot Table

There are many more!

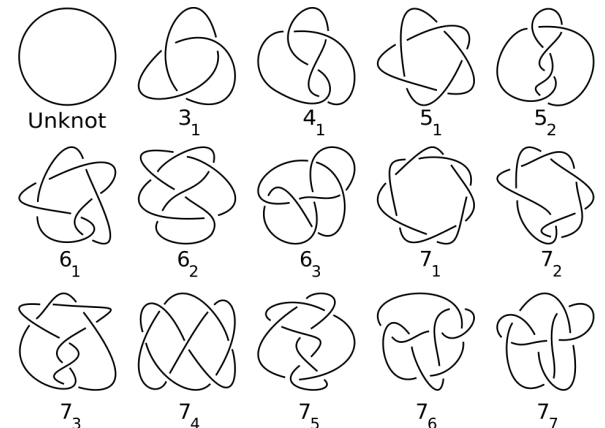

Roseman Moves.

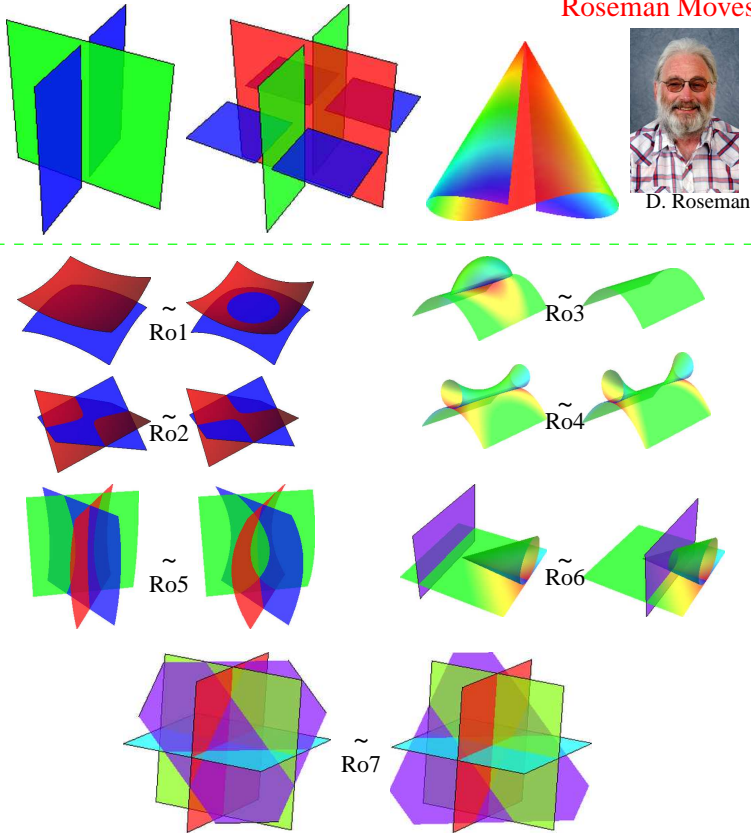

Some knot theory books.

Colin C. Adams, *The Knot Book, an Elementary Introduction to the Mathematical Theory of Knots*, American Mathematical Society, 2004.
 Meike Akveld and Andrew Jobbings, *Knots Unravelled, from Strings to Mathematics*, Arbelos 2011.
 J. Scott Carter and Masahico Saito, *Knotted Surfaces and Their Diagrams*, American Mathematical Society, 1997.
 Peter Cromwell, *Knots and Links*, Cambridge University Press, 2004.
 W.B. Raymond Lickorish, *An Introduction to Knot Theory*, Springer 1997.



3-Colourings in 4D

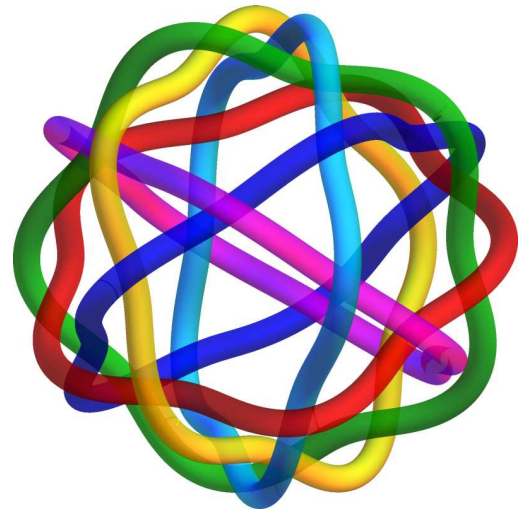
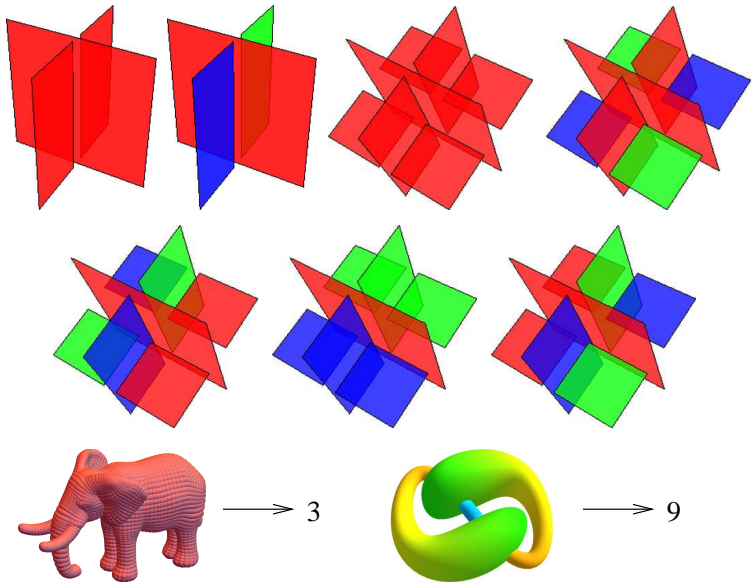

Some knots for the practically-minded

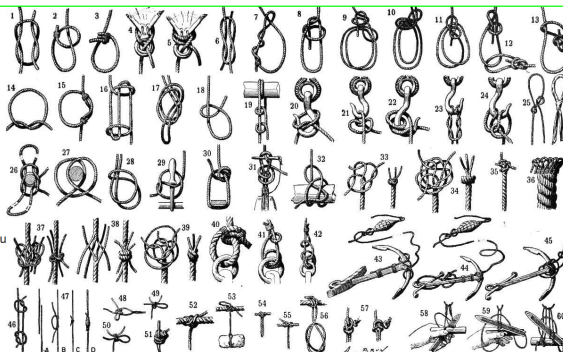

Le Larousse pour tous : nouveau dictionnaire encyclopédique
 by Larousse, 1977, 1978, 1979, 1980, 1981, 1982, 1983, 1984, 1985, 1986, 1987, 1988, 1989, 1990, 1991, 1992, 1993, 1994, 1995, 1996, 1997, 1998, 1999, 2000, 2001, 2002, 2003, 2004, 2005, 2006, 2007, 2008, 2009, 2010, 2011, 2012, 2013, 2014, 2015, 2016, 2017, 2018, 2019, 2020, 2021, 2022, 2023, 2024, 2025

ω/LL



“God created the knots, all else in topology is the work of mortals.”

Leopold Kronecker (modified)

www.katlas.org



Banks like knots. Which knot appears twice?